



**TS951
TS952
TS954**

INPUT/OUTPUT RAIL TO RAIL LOW POWER OPERATIONAL AMPLIFIERS

- RAIL TO RAIL **INPUT** COMMON-MODE VOLTAGE RANGE
- RAIL TO RAIL **OUTPUT** VOLTAGE SWING
- OPERATING FROM **2.7V to 12V**
- HIGH SPEED (**3MHz, 1V/μs**)
- LOW CONSUMPTION (**0.9mA @ 3V**)
- SUPPLY VOLTAGE REJECTION RATIO : **80dB**
- ESD PROTECTION (**2kV**)
- LATCH-UP IMMUNITY
- AVAILABLE IN **SOT23-5 MICROPACKAGE**

DESCRIPTION

The TS95x family are RAIL TO RAIL BiCMOS operational amplifiers optimized and fully specified for 3V and 5V operation.

The TS951 is housed in the space-saving 5 pins SOT23 package that makes it well suited for battery-powered systems. This micropackage simplifies the PC board design because of its ability to be placed in tight spaces (outside dimensions are : 2.8mm x 2.9mm)

APPLICATIONS

- Set-top boxes
- Laptop/Notebook computers
- Transformer/Line drivers
- Personal entertainments (CD players)
- Portable communication (cell phones, pagers)
- Instrumentation & sensing
- Digital to Analog converter buffers
- Portable headphone speaker drivers

ORDER CODES

Part Number	Temperature Range	Package				SOT23 Marking
		N	D	P	L	
TS951I	-40, +125°C		•		•	K101
TS952I	-40, +125°C	•	•	•		
TS954I	-40, +125°C	•	•	•		

N = Dual in Line Package (DIP)

D = Small Outline Package (SO) - also available in Tape & Reel

P = Thin Shrink Small Outline Package (TSSOP) - only available in Tape & Reel (PT)

L = Tiny Package (SOT23-5) - only available in Tape & Reel (LT)

PIN CONNECTIONS (top view)

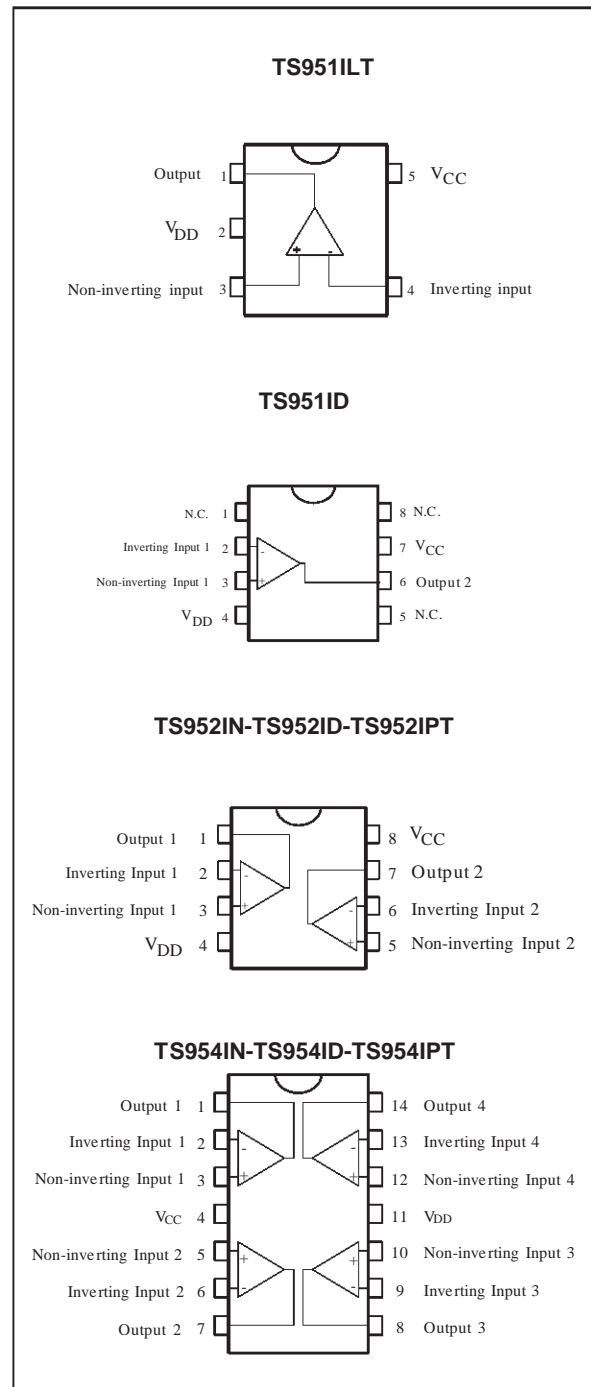

ABSOLUTE MAXIMUM RATINGS

Symbol	Parameter	Value	Unit
V _{CC}	Supply Voltage - note 1	12	V
V _{id}	Differential Input Voltage - note 2	±1	V
V _{in}	Input Voltage Range - note 3	-0.3 to 12.3	V
T _{oper}	Operating Free Air Temperature Range	-40 to +125	°C
T _{stg}	Storage Temperature Range	-65 to +150	°C
T _j	Maximum Junction Temperature	150	°C
R _{thjc}	Thermal Resistance Junction to Case - note 4 SOT23-5 SO8 SO14 TSSOP8 TSSOP14	81 28 22 26 21	°C/W
R _{thja}	Thermal Resistance Junction to Ambient - SOT23-5	256	°C/W
ESD	Human Body Model	2	kV
	Lead Temperature (soldering, 10sec)	260	°C

- Notes:**
1. All voltages values, except differential voltage are with respect to network ground terminal.
 2. Differential voltages are non-inverting input terminal with respect to the inverting input terminal.
 3. The magnitude of input and output voltages must never exceed V_{CC} +0.3V.
 4. Short-circuits can cause excessive heating and destructive dissipation.

OPERATING CONDITIONS

Symbol	Parameter	Value	Unit
V _{CC}	Supply Voltage Range	2.7 to 12	V
V _{icm}	Common Mode Input Voltage Range	V _{DD} - 0.2 to V _{CC} + 0.2	V

ELECTRICAL CHARACTERISTICS

$V_{CC} = +3V$, $V_{DD} = 0V$, $T_{amb} = 25^{\circ}C$ (unless otherwise specified)

Symbol	Parameter	Min.	Typ.	Max.	Unit
V_{io}	Input Offset Voltage $T_{min.} \leq T_{amb} \leq T_{max.}$			6 8	mV
DV_{io}	Input Offset Voltage Drift		2		$\mu V/^{\circ}C$
I_{io}	Input Offset Current $T_{min.} \leq T_{amb} \leq T_{max.}$		1	30 80	nA
I_{ib}	Input Bias Current $V_{icm} = 1.5V$ $T_{min.} \leq T_{amb} \leq T_{max.}$		35	100 200	nA
V_{icm}	Common Mode Input Voltage Range	$V_{DD} - 0.2$ to $V_{CC} + 0.2$			V
CMR	Common Mode Rejection Ratio	50	80		dB
SVR	Supply Voltage Rejection Ratio $V_{CC} = 2.7V$ to $3.3V$	60	80		dB
A_{vd}	Large Signal Voltage Gain $V_o = 2V_{pk-pk}$ $R_L = 600\Omega$		80		dB
V_{OH}	High Level Output Voltage $R_L = 600\Omega$	2.8	2.9		V
V_{OL}	Low Level Output Voltage $R_L = 600\Omega$		80	250	mV
I_{sc}	Output Short Circuit Current	10			mA
I_{CC}	Supply Current (per amplifier) No load, $V_o = V_{CC}/2$		0.9	1.3	mA
GBP	Gain Bandwidth Product $R_L = 2k\Omega$		3		MHz
SR	Slew Rate		1		$V/\mu s$
ϕ_m	Phase Margin at Unity Gain $R_L = 600\Omega$, $C_L = 100pF$		60		Degrees
G_m	Gain Margin $R_L = 600\Omega$, $C_L = 100pF$		10		dB
e_n	Equivalent Input Noise Voltage $f = 1kHz$		25		$\frac{nV}{\sqrt{Hz}}$
THD	Total Harmonic Distortion $V_o = 4V_{pk-pk}$, $f = 10kHz$, $A_V = 2$, $R_L = 10k\Omega$		0.01		%

ELECTRICAL CHARACTERISTICS

$V_{CC} = +5V$, $V_{DD} = 0V$, $T_{amb} = 25^{\circ}C$ (unless otherwise specified)

Symbol	Parameter	Min.	Typ.	Max.	Unit
V_{io}	Input Offset Voltage $T_{min.} \leq T_{amb} \leq T_{max.}$			6 8	mV
DV_{io}	Input Offset Voltage Drift		2		$\mu V/^{\circ}C$
I_{io}	Input Offset Current $T_{min.} \leq T_{amb} \leq T_{max.}$		1	30 80	nA
I_{ib}	Input Bias Current $V_{icm} = 1.5V$ $T_{min.} \leq T_{amb} \leq T_{max.}$		35	100 200	nA
V_{icm}	Common Mode Input Voltage Range	$V_{DD} - 0.2$ to $V_{CC} + 0.2$			V
CMR	Common Mode Rejection Ratio	50	80		dB
SVR	Supply Voltage Rejection Ratio $V_{CC} = 2.7V$ to $3.3V$	60	80		dB
A_{vd}	Large Signal Voltage Gain $V_o = 2V_{pk-pk}$ $R_L = 600\Omega$		86		dB
V_{OH}	High Level Output Voltage $R_L = 600\Omega$	4.7	4.8		V
V_{OL}	Low Level Output Voltage $R_L = 600\Omega$		80	300	mV
I_{sc}	Output Short Circuit Current	10			mA
I_{CC}	Supply Current (per amplifier) No load, $V_o = V_{CC}/2$		0.95	1.4	mA
GBP	Gain Bandwidth Product $R_L = 2k\Omega$		3		MHz
SR	Slew Rate		1		$V/\mu s$
ϕ_m	Phase Margin at Unity Gain $R_L = 600\Omega$, $C_L = 100pF$		60		Degrees
G_m	Gain Margin $R_L = 600\Omega$, $C_L = 100pF$		10		dB
e_n	Equivalent Input Noise Voltage $f = 1kHz$		25		$\frac{nV}{\sqrt{Hz}}$
THD	Total Harmonic Distortion $V_o = 4V_{pk-pk}$, $f = 10kHz$, $A_V = 2$, $R_L = 10k\Omega$		0.01		%

SUPPLY CURRENT VERSUS SUPPLY VOLTAGE

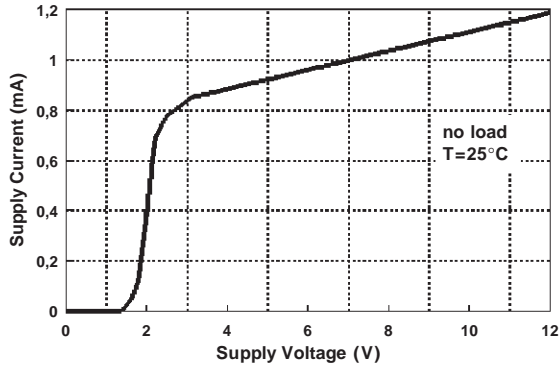

SUPPLY CURRENT VERSUS TEMPERATURE

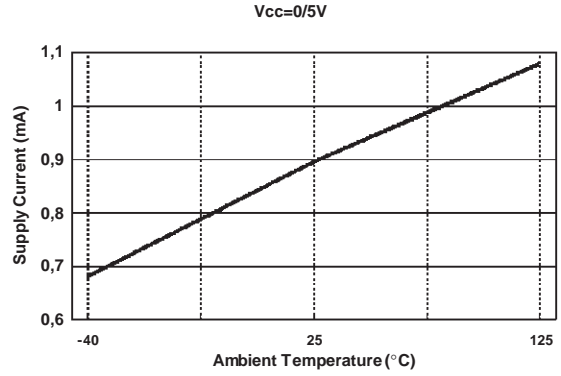

OUTPUT SHORT CIRCUIT CURRENT VERSUS OUTPUT VOLTAGE

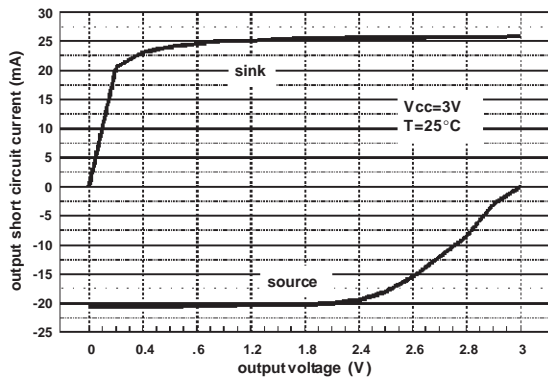

OUTPUT SHORT CIRCUIT CURRENT VERSUS TEMPERATURE

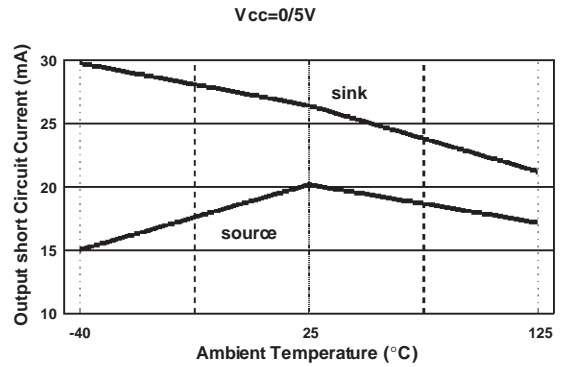

VOLTAGE GAIN AND PHASE VERSUS FREQUENCY

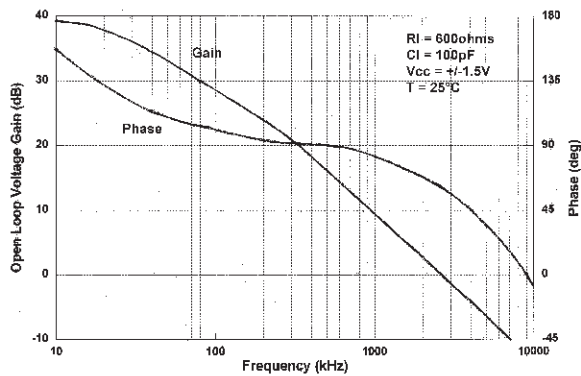

SLEW RATE VERSUS TEMPERATURE

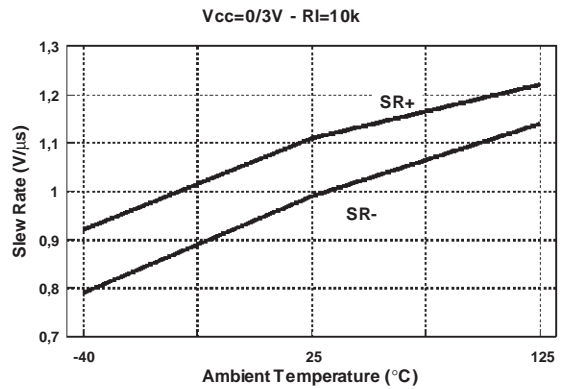

THD + NOISE VERSUS V_{out}

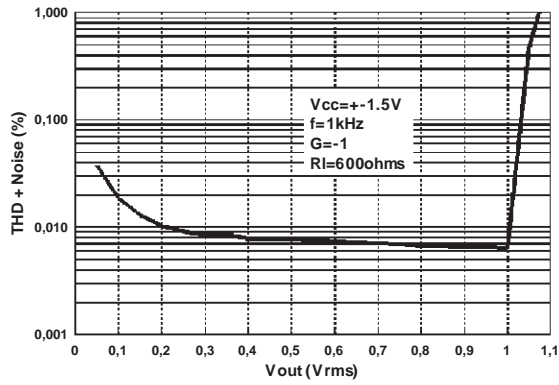

THD + NOISE VERSUS V_{out}

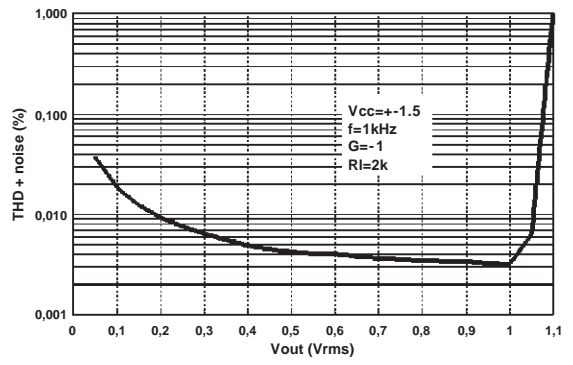

THD + NOISE VERSUS FREQUENCY

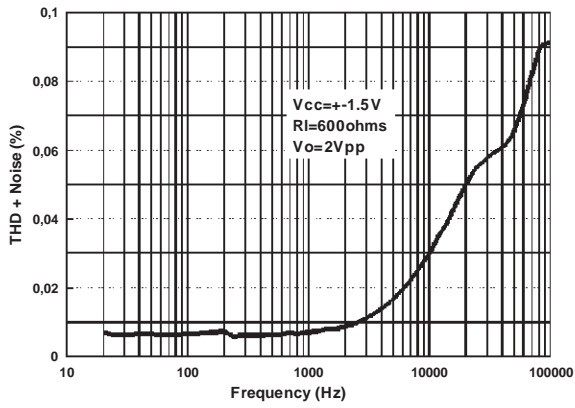

EQUIVALENT INPUT NOISE VOLTAGE VERSUS FREQUENCY

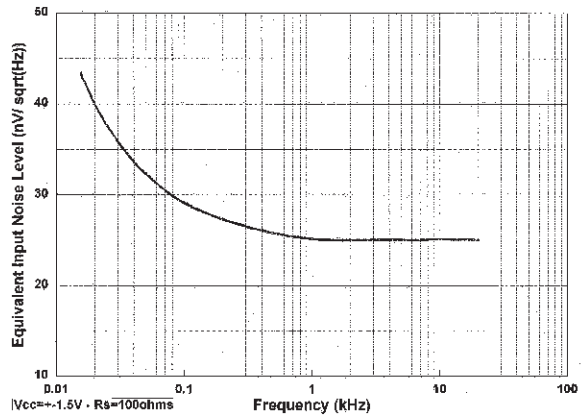

TS952IN

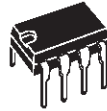

PACKAGE MECHANICAL DATA
8 PINS - PLASTIC PACKAGE

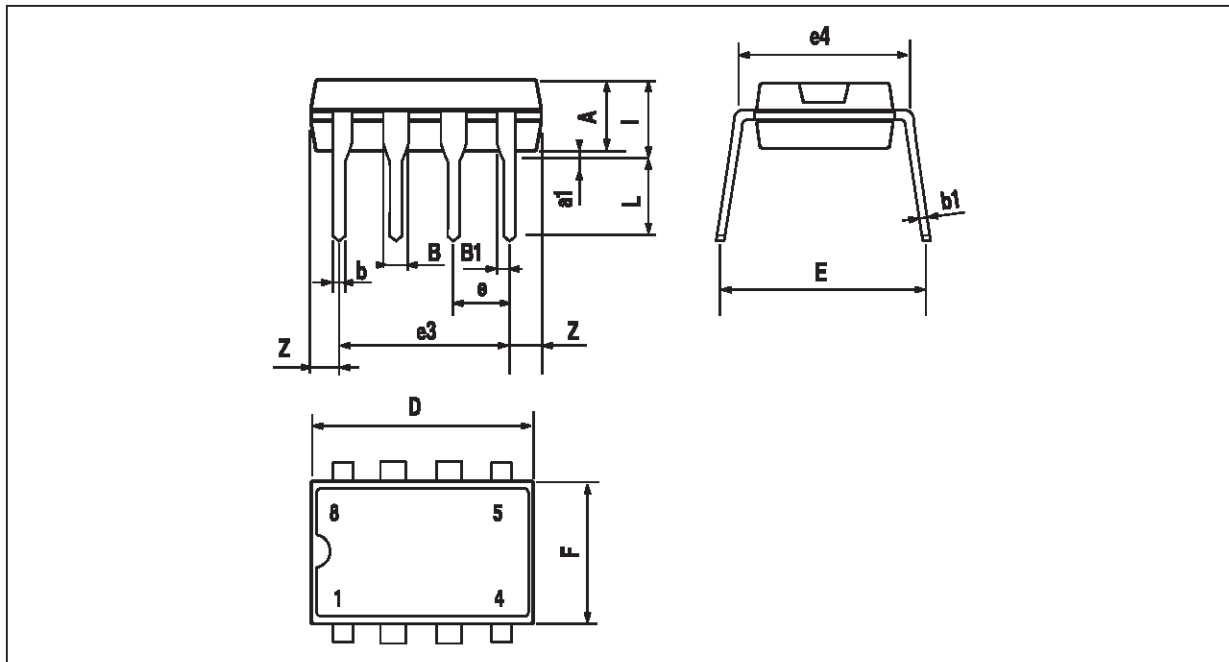

Dimensions	Millimeters			Inches		
	Min.	Typ.	Max.	Min.	Typ.	Max.
A		3.32			0.131	
a1	0.51			0.020		
B	1.15		1.65	0.045		0.065
b	0.356		0.55	0.014		0.022
b1	0.204		0.304	0.008		0.012
D			10.92			0.430
E	7.95		9.75	0.313		0.384
e		2.54			0.100	
e3		7.62			0.300	
e4		7.62			0.300	
F			6.6			0.260
i			5.08			0.200
L	3.18		3.81	0.125		0.150
Z			1.52			0.060

TS951-TS952-TS954

TS951ID-TS952ID



PACKAGE MECHANICAL DATA
8 PINS - PLASTIC MICROPACKAGE (SO)

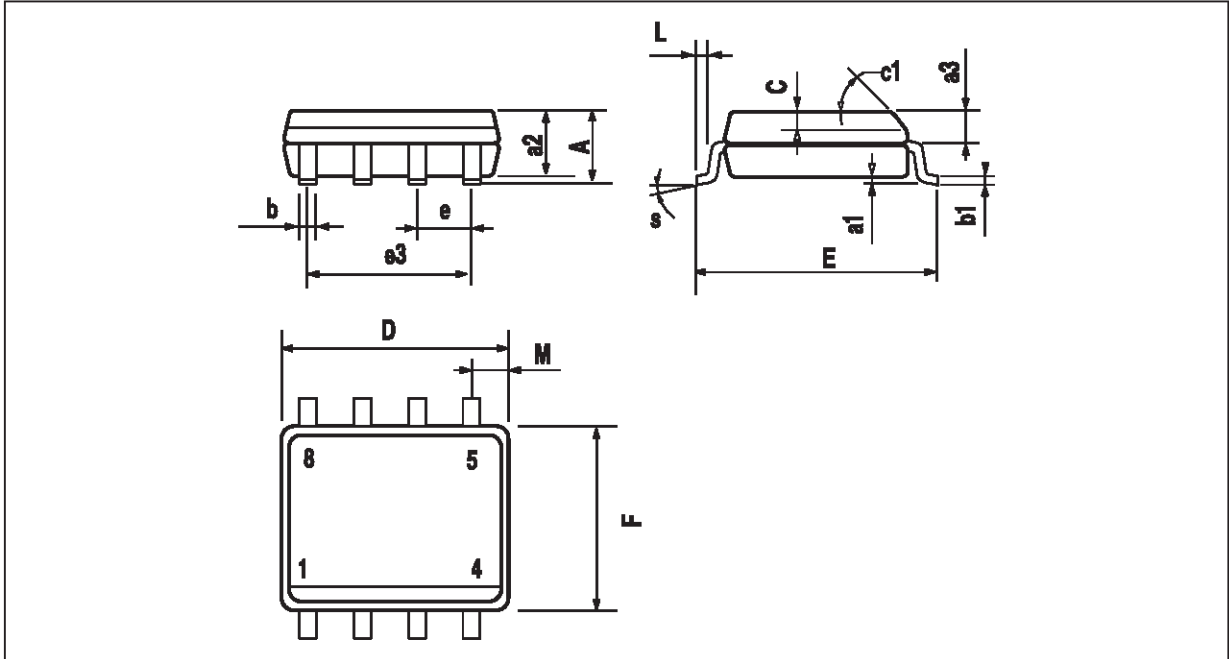

Dim.	Millimeters			Inches		
	Min.	Typ.	Max.	Min.	Typ.	Max.
A			1.75			0.069
a1	0.1		0.25	0.004		0.010
a2			1.65			0.065
a3	0.65		0.85	0.026		0.033
b	0.35		0.48	0.014		0.019
b1	0.19		0.25	0.007		0.010
C	0.25		0.5	0.010		0.020
c1	45° (typ.)					
D	4.8		5.0	0.189		0.197
E	5.8		6.2	0.228		0.244
e		1.27			0.050	
e3		3.81			0.150	
F	3.8		4.0	0.150		0.157
L	0.4		1.27	0.016		0.050
M			0.6			0.024
S	8° (max.)					

TS952IPT



PACKAGE MECHANICAL DATA
8 PINS - THIN SHRINK SMALL OUTLINE PACKAGE

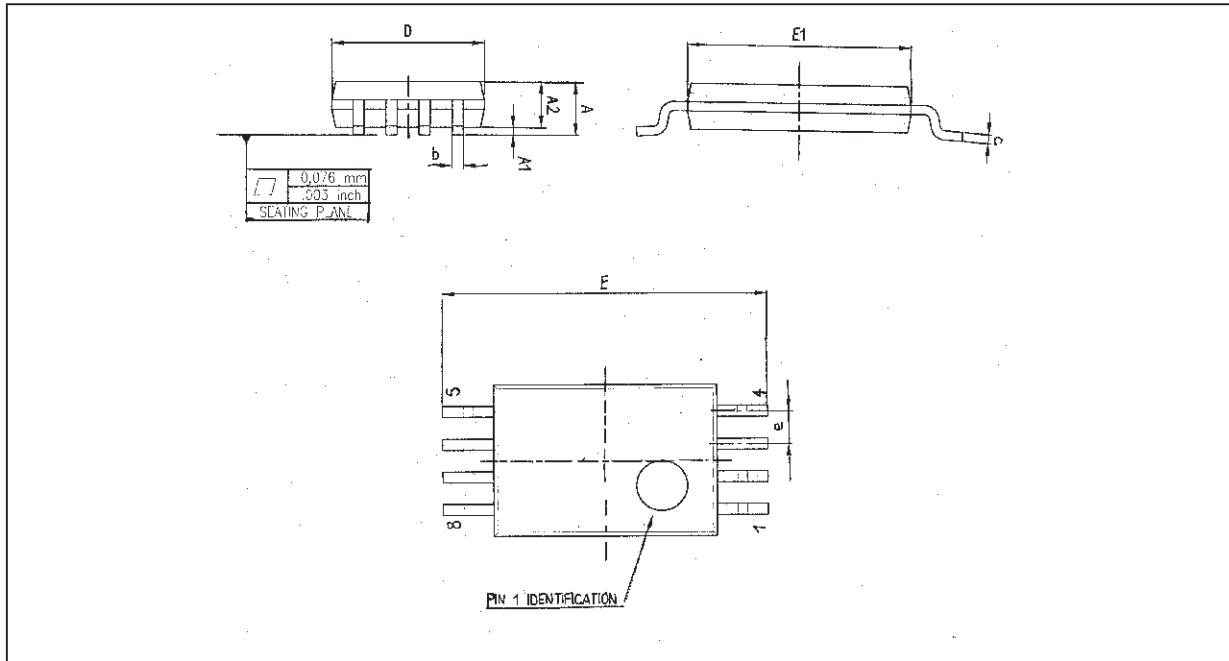

Dim.	Millimeters			Inches		
	Min.	Typ.	Max.	Min.	Typ.	Max.
A			1.20			0.05
A1	0.05		0.15	0.01		0.006
A2	0.80	1.00	1.05	0.031	0.039	0.041
b	0.19		0.30	0.007		0.15
c	0.09		0.20	0.003		0.012
D	2.90	3.00	3.10	0.114	0.118	0.122
E		6.40			0.252	
E1	4.30	4.40	4.50	0.169	0.173	0.177
e		0.65			0.025	
k	0°		8°	0°		8°
l	0.50	0.60	0.75	0.09	0.0236	0.030

TS951-TS952-TS954

TS954IN

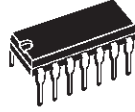

PACKAGE MECHANICAL DATA
14 PINS - PLASTIC PACKAGE

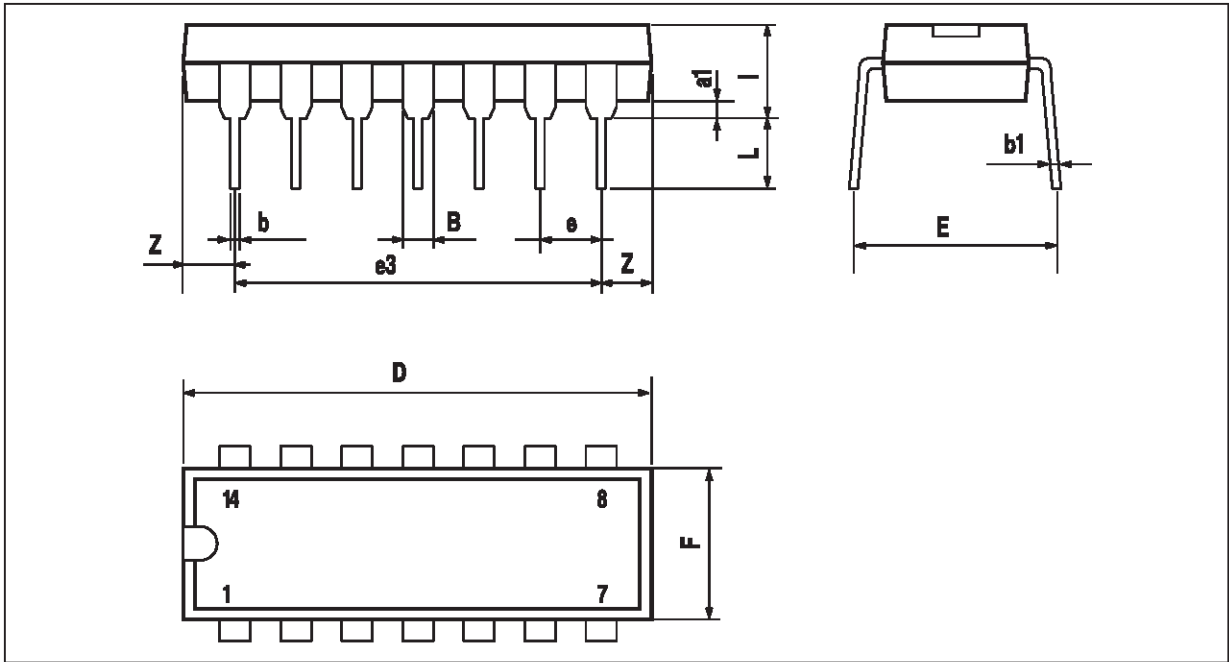

Dim.	Millimeters			Inches		
	Min.	Typ.	Max.	Min.	Typ.	Max.
a1	0.51			0.020		
B	1.39		1.65	0.055		0.065
b		0.5			0.020	
b1		0.25			0.010	
D			20			0.787
E		8.5			0.335	
e		2.54			0.100	
e3		15.24			0.600	
F			7.1			0.280
i			5.1			0.201
L		3.3			0.130	
Z	1.27		2.54	0.050		0.100

TS954ID

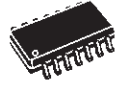

PACKAGE MECHANICAL DATA
14 PINS - PLASTIC MICROPACKAGE (SO)

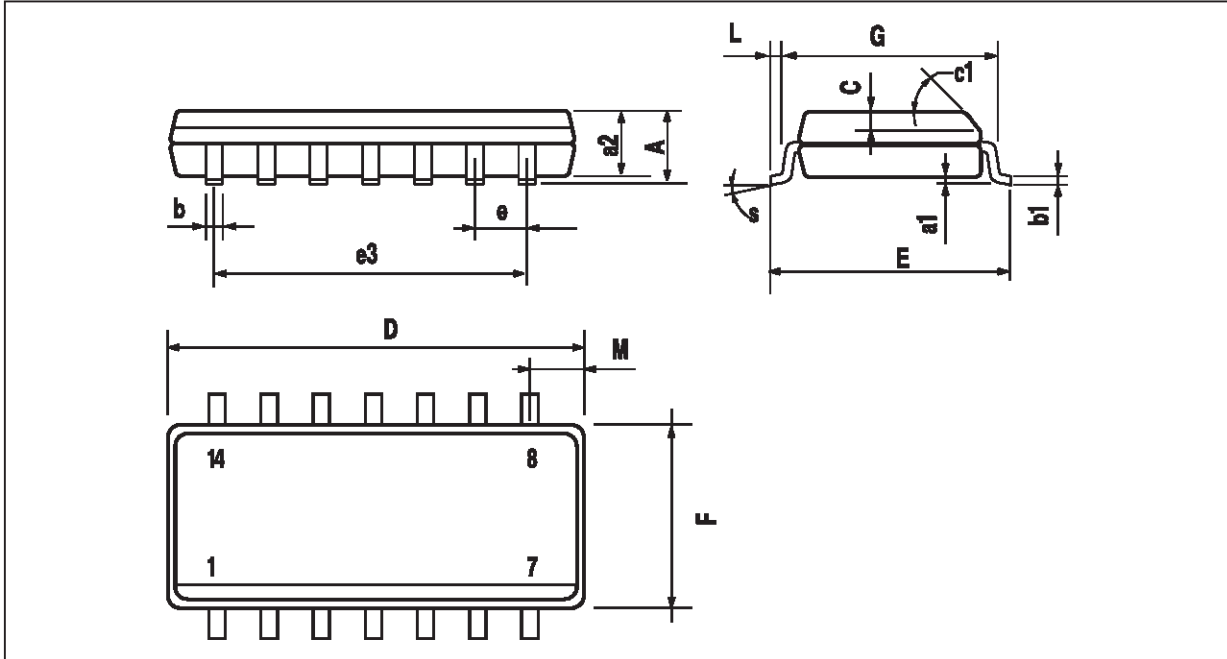

Dim.	Millimeters			Inches		
	Min.	Typ.	Max.	Min.	Typ.	Max.
A			1.75			0.069
a1	0.1		0.2	0.004		0.008
a2			1.6			0.063
b	0.35		0.46	0.014		0.018
b1	0.19		0.25	0.007		0.010
C		0.5			0.020	
c1	45° (typ.)					
D	8.55		8.75	0.336		0.334
E	5.8		6.2	0.228		0.244
e		1.27			0.050	
e3		7.62			0.300	
F	3.8		4.0	0.150		0.157
G	4.6		5.3	0.181		0.208
L	0.5		1.27	0.020		0.050
M			0.68			0.027
S	8° (max.)					

TS951-TS952-TS954

TS954IPT



PACKAGE MECHANICAL DATA 14 PINS - THIN SHRINK SMALL OUTLINE PACKAGE

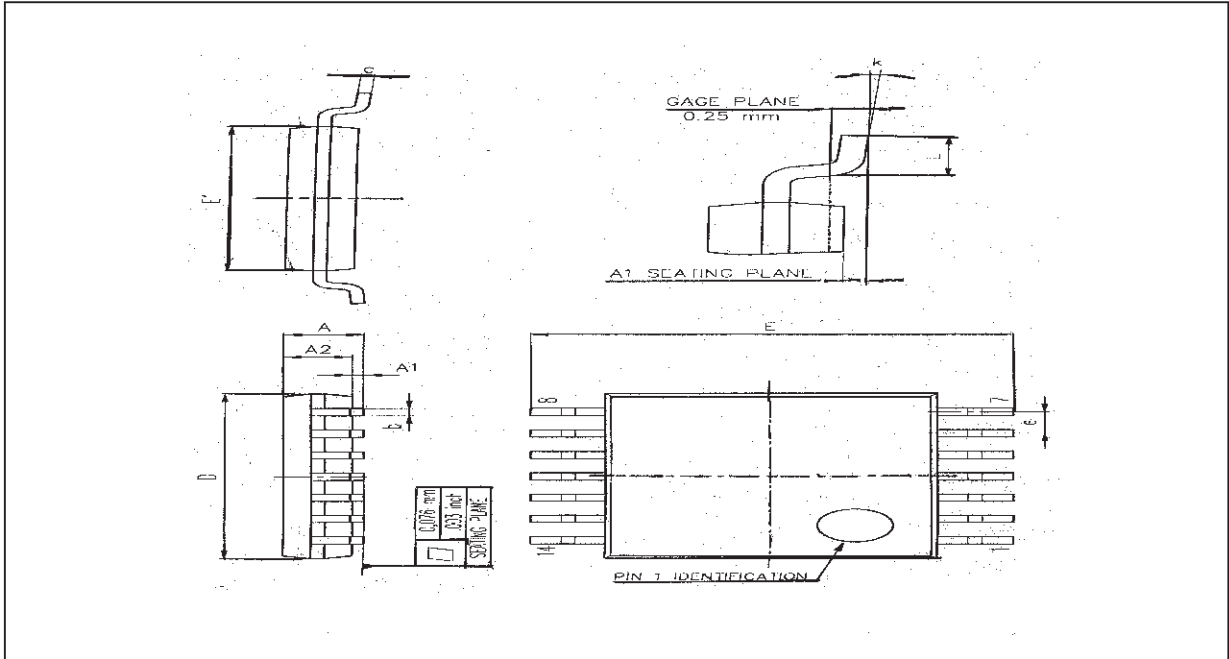

Dim.	Millimeters			Inches		
	Min.	Typ.	Max.	Min.	Typ.	Max.
A			1.20			0.05
A1	0.05		0.15	0.01		0.006
A2	0.80	1.00	1.05	0.031	0.039	0.041
b	0.19		0.30	0.007		0.15
c	0.09		0.20	0.003		0.012
D	4.90	5.00	5.10	0.192	0.196	0.20
E		6.40			0.252	
E1	4.30	4.40	4.50	0.169	0.173	0.177
e		0.65			0.025	
k	0°		8°	0°		8°
l	0.50	0.60	0.75	0.09	0.0236	0.030

TS951ILT



PACKAGE MECHANICAL DATA
5 PINS -TINY PACKAGE (SOT23)

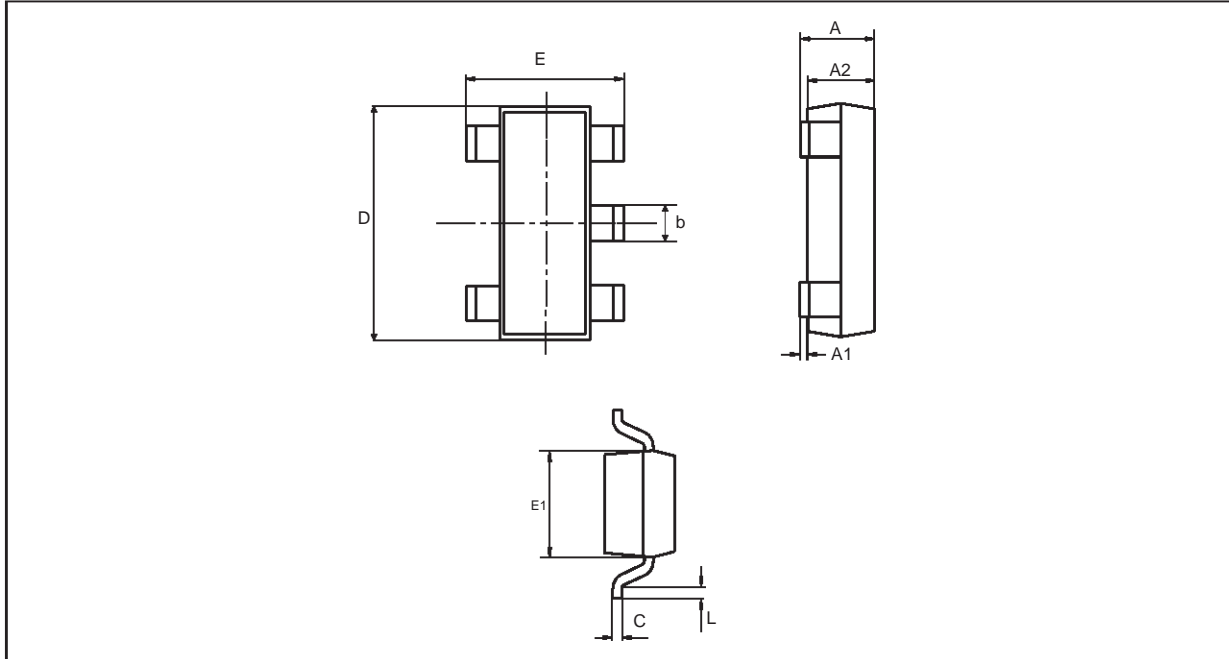

Dim.	Millimeters		Inches	
	Min.	Max.	Min.	Max.
A	0.90	1.45	0.034	0.057
A1	0	0.15		0.006
A2	0.90	1.30	0.034	0.051
b	0.35	0.50	0.013	0.020
C	0.09	0.20	0.003	0.008
D	2.80	3.00	0.110	0.118
E	2.60	3.00	0.102	0.118
E1	1.50	1.75	0.059	0.069
L	0.10	0.60	0.003	0.024

Information furnished is believed to be accurate and reliable. However, STMicroelectronics assumes no responsibility for the consequences of use of such information nor for any infringement of patents or other rights of third parties which may result from its use. No license is granted by implication or otherwise under any patent or patent rights of STMicroelectronics. Specifications mentioned in this publication are subject to change without notice. This publication supersedes and replaces all information previously supplied. STMicroelectronics products are not authorized for use as critical components in life support devices or systems without express written approval of STMicroelectronics.

© The ST logo is a trademark of STMicroelectronics

© 1999 STMicroelectronics – Printed in Italy – All Rights Reserved

STMicroelectronics GROUP OF COMPANIES

Australia - Brazil - China - Finland - France - Germany - Hong Kong - India - Italy - Japan - Malaysia - Malta - Morocco
Singapore - Spain - Sweden - Switzerland - United Kingdom - U.S.A.

© <http://www.st.com>

